

MP3/CD Language Learning Machine

AZ 6188



PHILIPS

Mexico

Es necesario que lea cuidadosamente su instructivo de manejo.



Descripción: **Radio grabadora AM/FM con reproductor de CD**
Modelo: **AZ 6188/01**
Alimentación: **110-127/220-240 V; ~50-60 Hz**
Consumo: **13 W**
Importador: **Philips Mexicana, S.A. de C.V.**
Domicilio: **Norte 45, # 669, Col. Industrial Vallejo**
Localidad y Telefono: **C.P. 02300 México D.F.,
Tel. 57284200**
Exportador: **Philips Electronics HK, Ltd.**
País de Origen: **China**
N° de Serie: _____

LEA CUIDADOSAMENTE ESTE INSTRUCTIVO ANTES DE USAR SU APARATO.

AVISO IMPORTANTE

Philips Mexicana, S.A. de C.V. no se hace responsable por daños o desperfectos causados por:

- *Maltrato, descuido o mal uso, presencia de insectos o roedores (cucarachas, ratones etc.).*
- *Cuando el aparato no haya sido operado de acuerdo con el instructivo del uso, fuera de los valores nominales y tolerancias de las tensiones (voltaje), frecuencia (ciclaje) de alimentación eléctrica y las características que deben reunir las instalaciones auxiliares.*
- *Por fenómenos naturales tales como: temblores, inundaciones, incendios, descargas eléctricas, rayos etc. o delitos causados por terceros (choques asaltos, riñas, etc.).*

CAUTION

Use of controls or adjustments or performance of procedures other than herein may result in hazardous radiation exposure or other unsafe operation.

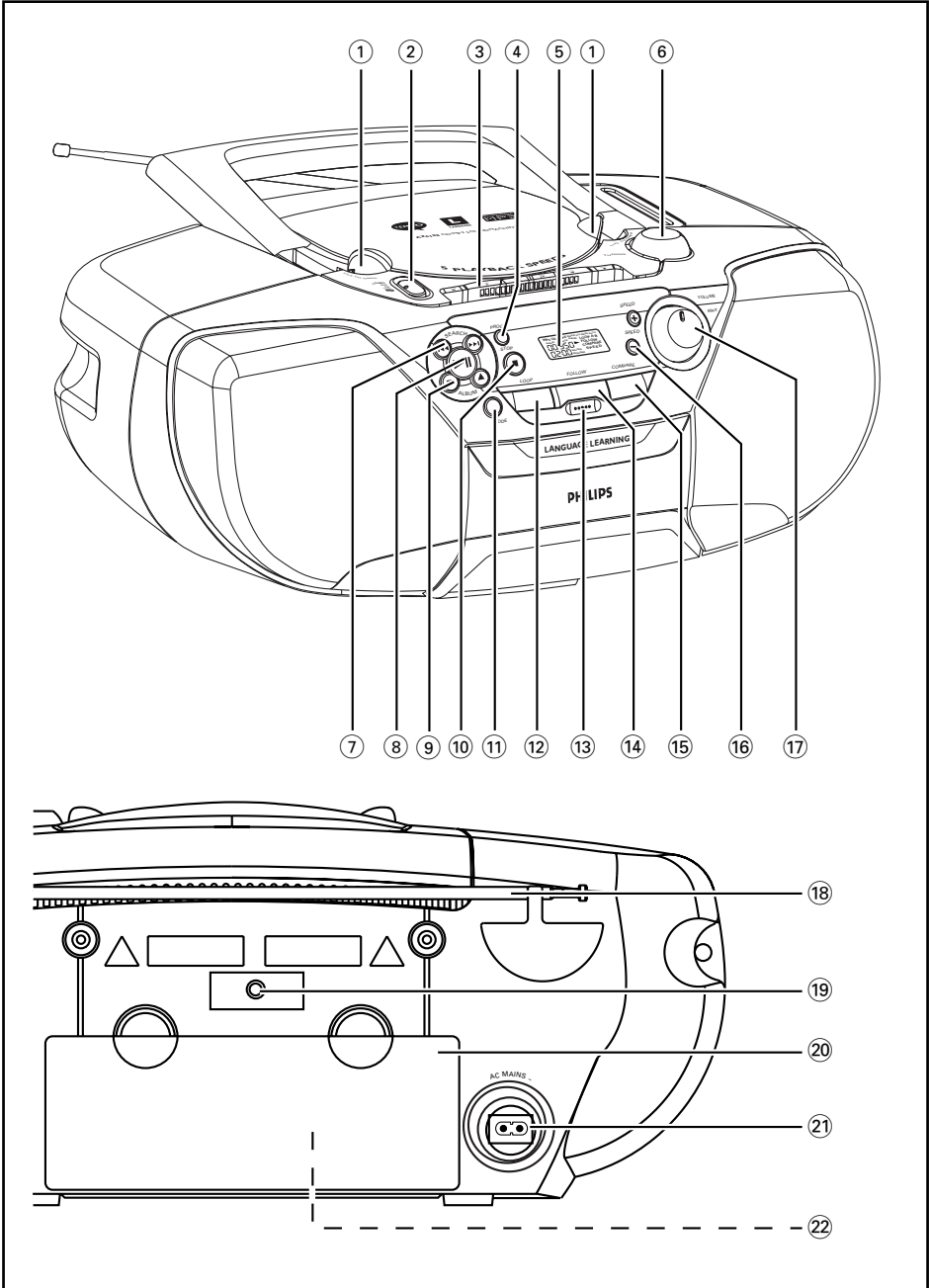

Index

English

English ————— 5

Français

Français ————— 22

Español

Español ————— 39

中文

中文 ————— 56

Guarantees

(AUS) Australia ————— **73**

(NZ) New Zealand ————— **74**

(MEX) México ————— **75-76**

Dear Customer,

Thank you for buying the Philips MP3-CD Language Learning Machine. Your great new acquisition will allow you to listen to up to 10 hours of CD-like quality music, using the revolutionary new music compression technology MP3.

MP3 technology

MP3 is short for MPEG1 Layer-3 encoding and decoding technology, a very powerful encoding algorithm with which you can shrink down the original digital audio data with a factor of up to 10 without losing significant sound quality.

Recording and Playback

It is recommended to set your recording bit rate to 128kbps and sampling frequency at 44.1kHz to achieve CD-like music playback quality.

Since downloading MP3 files from the Internet, ripping songs from your own legal CD's and burning MP3 songs onto a CD-R, are a delicate process, the quality of an MP3 song may vary according to this process. Subsequently, making an MP3-CD may not be entirely perfect.

As a result of the above imperfection, you may experience an occasional “skip” while listening, or an occasional delay in accessing “previous/next” title to MP3-CDs. This is considered to be normal.

A comparison chart is enclosed as below:

Sound Quality	Bit Rate	Approximate Reduction Ratio	Approximate total MP3-CD time	Comment
AM radio	32 kbps	40 : 1	40 hrs	Sound quality significantly
FM radio	64 kbps	20 : 1	20 hrs	affected-not recommended.
Near-CD	96 kbps	15 : 1	15 hrs	Balanced sound quality
CD-like	128 kbps	10 : 1	10 hrs	compression rate.
CD	256 kbps	5 : 1	5 hrs	Compression rate low
CD	320 kbps	3 : 1	3 hrs	suggest to play CDs instead.

CONTROLS

TOP AND FRONT PANEL

- ① **LIFT TO OPEN** - to open the CD door.
- ② **Source selector** - POWER ON/OFF switch and to select source of sound source:
CD•MP3/MW/FM/TAPE(OFF).
- ③ **Cassette keys:**
PAUSE II - to interrupt recording or playback.
STOP•OPEN ■ ▲ - To stop the tape and to open the cassette holder.
SEARCH ◀◀ or ▶▶ - to fast wind/rewind the tape.
PLAY ◀ - to start playback.
RECORD ● - to start recording.
- ④ **PROG -**
- to program disc tracks in CD/MP3 playback mode.
- to set Point B for A-B playback in the language learning mode.
- ⑤ **LCD Display** - to show the MP3 functions and disc status.
- ⑥ **TUNING** - to tune to radio stations
- ⑦ **SEARCH ◀◀ or ▶▶**
- to skip or search a passage or a track
- In the language learning mode, to set Auto Loop, Follow, Compare, and adjust the number of sentence breaks.
- ⑧ **PLAY•PAUSE ▶▶II**
- to start or interrupt CD playback
- to clear recorded contents in language learning mode
- ⑨ **ALBUM ▲ / ▼**
- to select the desired album up or down in MP3 CD playback mode.
- to adjust the repeat times in the language learning mode.
- ⑩ **STOP ■** - to stop playback
- ⑪ **MODE**
- to select REPEAT, REPEAT ALL, SHUFFLE or SHUFFLE ALL in the music mode.
- to toggle between LANG ON and LANG OFF modes.
- to toggle between AUTO and MANU in the language learning mode.

- ⑫ **LOOP** - to activate the LOOP language learning mode.
- ⑬ **MIC** - to input voice in the recording mode.
- ⑭ **FOLLOW** - to activate the FOLLOW language learning mode.
- ⑮ **COMPARE** - to activate the COMPARE language learning mode
- ⑯ **SPEED + / -** - to select the desired playing speed in the language learning mode.
- ⑰ **VOLUME** - to adjust volume level.

BACK PANEL

- ⑱ **Telescopic aerial** - to improve FM radio reception
- ⑲ **🎧** - 3.5mm stereo headphone socket
Note: The speakers will be muted when the headphones are connected to the set.
- ⑳ **Battery door** - to open the battery compartment
- ㉑ **AC MAINS ~** - socket for mains lead
- ㉒ **Voltage selector** (*inside battery compartment, some versions only*) - Adjust to match the local voltage 110/220V before plugging in the set

BATTERIES (NOT SUPPLIED)

Whenever convenient, use the mains supply if you want to conserve battery life. The battery supply will be switched off when the set is connected to the mains. Make sure you remove the plug from the set and wall outlet before inserting batteries.

Batteries

1. Open the battery compartment and insert six batteries, type **R14, UM2** or **C-cells, (preferably alkaline)** with the correct polarity as indicated by the "+" and "-" symbols inside the compartment.
2. Replace the compartment door, making sure the batteries are firmly and correctly in place.
3. Remove the batteries if they are exhausted or if they will not be used for a long period.

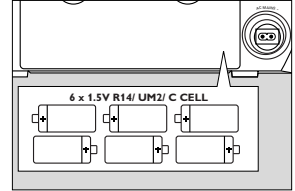

- Incorrect use of batteries can cause electrolyte leakage and will corrode the compartment or cause the batteries to burst. Therefore:
 - Do not mix battery types, e.g. alkaline with zinc carbonate.
 - When inserting new batteries, replace all at the same time.

Notes :

- The battery supply is switched off when the set is connected to the mains.

Batteries contain chemical substances, so they should be disposed of properly.

MAINS

1. Check if the mains voltage as shown on the type plate (on the bottom of the set) matches your local mains voltage. If it does not, consult your dealer or service organization.
2. If your set is equipped with a voltage selector; adjust the selector so that it matches with the local power supply.
3. Connect the mains lead to the **AC MAINS ~** socket and the wall socket.
 - The set is now ready for use.
4. To switch off the mains supply completely, pull the mains plug out of the wall socket.
 - Disconnect the mains lead when you change over to battery supply, or to protect the set during heavy thunderstorms.

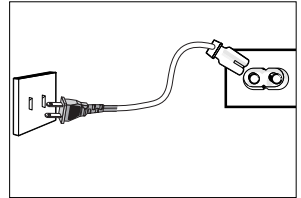

The type plate is located on the bottom of the set.

TUNER OPERATION

GENERAL OPERATION

1. To switch on the set, adjust the source selector.
2. Adjust the sound using the **VOLUME** control.
3. To switch off the set, adjust the source selector to the **TAPE/OFF** position, with the cassette keys released.

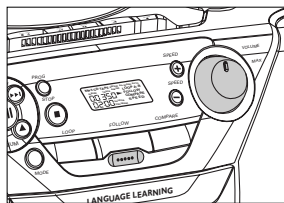

RADIO RECEPTION

1. Set the source selector to **FM** or **MW**.
2. Adjust the sound using the **VOLUME** control.
3. Tune to a radio station using the **TUNING** knob.
 - For FM, pull out the telescopic aerial. To improve FM-reception, incline and turn the aerial. Reduce its length if the FM-signal is too strong.
 - For MW, the set is provided with a built-in aerial, so the telescopic aerial is not needed. Direct the aerial by turning the whole set.
4. To switch off, set the source selector to the **TAPE/OFF** position (with the cassette keys released).

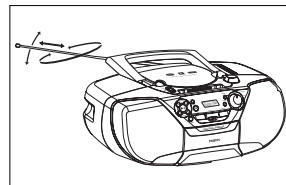
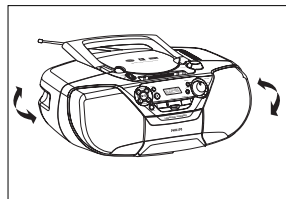

CAUTION

Use of controls or adjustments or performance of procedures other than herein described may result in hazardous radiation exposure or other unsafe operation.

Environmental information

Any unnecessary packaging material has been omitted. We have done our utmost to make the packaging easily separable into three mono materials: cardboard, polystyrene and plastic.

Your set consists of materials which can be recycled if disassembled by a specialized company. Please observe the local regulations regarding the disposal of packaging materials, exhausted batteries and old equipment.

DISCS FOR PLAYBACK

This set can play all digital audio CD, finalised digital audio CD-Recordable (CDR) discs and finalised digital audio CD-Rewritable (CDRW) discs.

Following MP3-CD formats are supported:

- ISO 9660 or ISO 9660 + Joliet format - Max. 30 characters
- Max. Track number is 400
- Max. nested directory is 8 levels
- The max. album number is 99
- The max. MP3 programme track number is 20
- The max. length of each track is 99 minutes 59 seconds
- The player can play mixed mode disc of CD / MP3-CD
- Supported VBR bit-rate
- Supported sampling frequencies for MP3 disc : 8 kHz to 48 kHz (44.1kHz preferably)
- Supported bit-rates of MP3 disc are: 32 - 320 kbps (128 kbps preferably)



Following formats are not supported

- The files like *.WMA, *.AAC, *.DLF, *.M3U, *.PLS, MP3 PRO
- Non-session closed discs

LOADING A DISC

1. Set the source selector to **CD**.
2. Lift to open the CD door.
→ "OPEN" will be displayed
3. Insert a disc with the label side facing up.
4. Close the CD door.
→ Playback starts from the first track.
→ The number and elapsed playing time of the first track are displayed.
→ "no disc" will be displayed if no disc is inserted or any error occurs in CD operation.

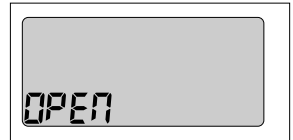

CD/MP3-CD

For MP3-CD only

- Playback starts from the first track of the first album.
- The MP3 icon album number and the elapsed playing time of the track are displayed.

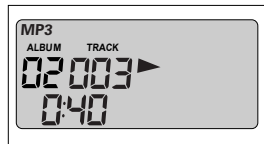

Notes :- To ensure good system performance, wait until the disc is completely read before proceeding.

- For MP3-CD, the disc reading time may exceed 1 minute due to the large number of songs compiled in one disc.

PLAYING A NORMAL DISC

1. Press **▶II** to start playback.

- The current track number and **▶** appear on the display.

• To interrupt playback, press **▶II**.

- **▶** and the current track number will appear; the elapsed playing time will flashing.

• To resume playback, press **▶II** again.

2. To stop playback, press **■**.

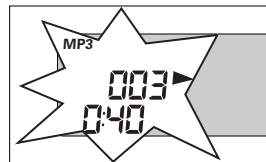

SELECTING A DESIRED TRACK/PASSAGE

To select a desired track

- Press **SEARCH** **◀◀** or **▶▶** repeatedly until the desired track appears on the display.
- If playback is stopped, press **▶II** to resume playback.

To search for a particular passage during playback

- Press and hold **SEARCH** **◀◀** or **▶▶** until you reach the beginning of your desired passage

For MP3-CD only

To select a desired album

- Press **ALBUM** **▲** or **▼** until the desired album number appears on the display.

To select a desired track

- Press **SEARCH** **◀◀** or **▶▶** repeatedly to select a desired track from the current album.

To select and play another track during playback

1. Press **SEARCH** **◀◀** or **▶▶** repeatedly to select another track.

- The selected track will appear on the display and playback continues.

PROGRAMMING TRACKS

Programming tracks of disc is possible when playback is stopped. Up to 20 tracks can be stored in the memory in any order.

1. Press **■** to stop playback.
2. Press **SEARCH** **◀◀** or **▶▶** to select the desired track, or for MP3-CD playback press **ALBUM** **▲** / **▼** to select the desired album .
3. Press **PROG** to store the select track. "X X" represents the track number.
 - Repeat steps **1** to **3** to store other tracks.
4. Press **■** to end programme setting.
 - **PROGRAM** will remain on the display.
 - You can press **◀◀** or **▶▶** to view the programmed tracks.
5. Press **▶||** to play the programmed tracks.
 - If you press **MODE** during program playback to activate **REPEAT** or **REPEAT ALL** function.
 - **REPEAT/REPEAT ALL** icon and **PROGRAM** will appear on the display.
6. Press twice to clear the programme.
 - **PROGRAM** will disappear from the display, and **ERROR** will appear, followed by the number of total tracks and the total playing time.

Note: - You can also press **PROG** to program tracks during normal playback

MODE

REPEAT

1. In the playback, pause or stop mode, press **MODE** to enable the **REPEAT** play function.
 - **REPEAT** - to repeat the current track.
 - **REPEAT ALL** - to repeat the whole disc
 - **REPEAT ALBUM** - to repeat the current album .
2. To exit the repeat mode, press **MODE** until the **REPEAT/REPEAT ALL** icon disappears.

Notes : - The Shuffle and Repeat play modes cannot be combined for playback.
 - The Repeat play mode is cancelled when you press the **STOP** button.

SHUFFLE

You can play all the tracks in a random order.

1. In the playback, pause or stop mode, press **MODE** to enable the SHUFFLE function.
 - **SHUFFLE** will appear on the display.
2. To exit the shuffle mode, press **■** or **MODE** until **SHUFFLE/SHUFFLE ALL** disappears.

LANGUAGE LEARNING

This set features language learning functions based on CD, MP3-CD and tape playback modes. To select your desired playback source, please adjust the source selector to TAPE, FM, MW or CD-PM3.

MUSIC MODE AND LANGUAGE LEARNING MODE

When the set is start for the first time, the set is in the music mode. In this case, you can play CD, MP3-CD or tape.

Note : - CD playback is not in the compressed playback mode, therefore the sound quality is not affected, but the language learning function is not activated.

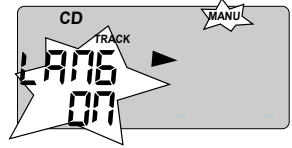

- Press and hold **MODE**, and **LANG ON** and **MANU** are displayed.
→ The language learning function is activated.

Notes : - In the language leaning mode, you can press **MODE** to toggle between manual and auto.
- To provide the 120-second repeat function in the CD playback mode, all the data in the CD will be first compressed and stored in the SD RAM for subsequent playback, therefore the sound quality might be slightly affected.
- Once in the language learning mode, **LANG ON** will disappear and **MANU** will remain flashing.

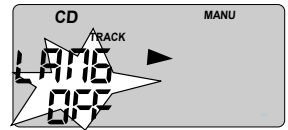

- Press and hold **MODE** again and **LANG OFF** is displayed.
The language learning function is deactivated.
→ Both **LANG ON** and **MANU** disappear.

STORE THE CONTENTS PLAYED, AND START MANUAL LOOP, FOLLOW OR COMPARE (LOOP, FOLLOW, COMPARE)

In the language learning mode, the contents played will be automatically stored in a Synchronous Dynamic Random Access Memory (SD RAM).

The storage periods are different according to different playback sources:

Playback source	Storage period
Tape	440 seconds
CD	120 seconds
MP3 128bpc	440 seconds

Notes : - For MP3-CDs of different bit rates, the storage periods may also be different. A smaller bit rate implies longer storage time. A greater bit rate implies shorter storage time. (64bps = 960 seconds, 320bps = 240 seconds).
- When the SD RAM is full, the latest contents will overwrite the older data in the principle of "First-in and first-out".

- Press **LOOP, FOLLOW** or **COMPARE** to start the manual loop, follow or compare mode for the contents stored.

HOW TO SELECT A PASSAGE FOR LANGUAGE LEARNING?

In CD or MP3-CD mode, when a track (or a text) has started, Press and hold **SEARCH** ◀◀ or **SEARCH** ▶▶ to go to the beginning of your desired track and then release the button; OR

- Wait until playback goes to the beginning of your desired track, and press **PLAY/PAUSE** ▶▶ to interrupt the playback, and then release this button to continue playback.

In this case, the set will clear all contents in its SD RAM and start recording the contents to be used for language learning.

Note : - After a new track (or text) is played, the set will automatically clear the old contents and start recording from the current playing time. This is to avoid interference between two tracks (or two texts).

- At the end of your desired track, press **LOOP, FOLLOW** or **COMPARE** to activate manual **LOOP, FOLLOW** or **COMPARE** mode.

In the tape playback mode, Press **PLAY** ▶ and the set will record the contents being played automatically.

- During tape playback, press **PLAY/PAUSE** ▶▶.
→ The contents previously stored will be cleared and the set starts to record new contents.

Therefore, if you want to select a passage for language learning, you can operate as per the following steps:

1. Stop tape playback (press ■, and then press **SEARCH** ◀◀ or **SEARCH** ▶▶ to go to the beginning of your desired passage. Release the key and then press **PLAY** ▶.
→ The set automatically starts to record the contents being played.
2. Press **PLAY/PAUSE** ▶▶ at the beginning of your desired track.
→ The set clears the contents previously stored and starts to record new contents being played automatically.
3. At the end of your desired passage, press **LOOP, FOLLOW** or **COMPARE** to start manual Loop, Follow and Compare.

MANUAL LOOP

- In the language learning mode, press **LOOP** to start manual loop
→ **LOOP** appears on the display.
→ The set will repeat the contents recorded and stored in the SD RAM. The repeat times is set as 3 by default

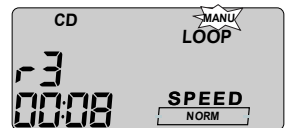

LANGUAGE LEARNING

- After three times, the set will resume to the normal playback mode and the next passage will be played and recorded in the SD RAM.
- During manual loop, you can press **ALBUM ▲/▼** to change the repeat times (3 times by default and 9 times at most).
→ r9 is displayed.
- During manual loop, you can press **PLAY/PAUSE ►||**.
→ The repeat stops. The next passage will be played normally.
- During manual loop, you can press **LOOP** to repeat the current passage (at the set repeat times).
- Press **FOLLOW** or **COMPARE** to activate the language learning function for the current passage.



Language Learning in **A-B** mode

During manual loop, you can set Point A and Point B and repeat the contents between the two points.

How to set **A-B** mode?

SET POINT A

- Press and hold **SEARCH ◀◀** or **SEARCH ▶▶** to go to the beginning of your desired passage, and release the button. This stop point is Point A.
→ The icon **A-B** blinks on the display.
- When playback goes to the end of your desired passage, press **PROG.**



This point is **Point B**.

→ After **A-B** is set, the contents between Point A and Point B will be played repeatedly.

Repeat Times

- The number of repeat times is the value manually set previously.
- After the last repeat, the system will quit the **A-B** mode and the manual repeat mode. Normal playback then starts from the next passage. The contents played are recorded in the SD RAM synchronously.

Notes : - During **A-B** playback, you can press **ALBUM ▲/▼** to change the repeat times (3 times by default and 9 times at most).

- During **A-B** playback, you can press **PLAY/PAUSE ►||** to interrupt **A-B** mode and quit the manual repeat mode, and start the next passage at the same time.
- During **A-B** playback, you can press **LOOP** to quit **A-B** mode to repeat the whole passage (at the repeat times previously set); You can also press **FOLLOW** or **COMPARE** to quit **A-B** mode to start follow or compare for the current passage.

AUTO LOOP

- In the manual Loop mode, you can press **MODE** to start Auto Loop.
→ **AUTO** flashes on the display.

Notes: - The current manual repeat will stop and will detect the sentence intervals from the next passage for automatic sentence break, and repeat one sentence or several sentences automatically.

- In the Auto Loop mode (during normal playback or repeat), you can press **SEARCH** ◀ or **SEARCH** ▶ to change the number of sentence breaks (1 by default or 9 at most).
- You can press **ALBUM A/V** to change the repeat times.
- During Auto Loop, you can press **PLAY/PAUSE** ▶|| to skip from the current passage to the next passage, OR
- Press **LOOP** to repeat the current passage (at the times previously set), OR
- Press **FOLLOW** or **COMPARE** to start Follow or Compare for the current passage, and enter the Auto Follow or Auto Compare mode.
- During normal playback in the Auto Loop mode, you can press **FOLLOW** or **COMPARE** to activate Auto Follow or Auto Compare.
- In the Auto Loop mode, you cannot activate the A-B language learning function

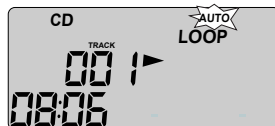

MANUAL FOLLOW

In the language learning mode, you can press **FOLLOW** to start Manual Follow.

- **FOLLOW** appears on the display.
- The set will play the recorded content for 1 time and then start recording.
- Playback and recording can be repeated (for 1 time by default).
- After 1 time of follow, the set will start normal playback automatically.



Notes: - The recording time equals the playback time. The whole process (playback + recording) will be repeated at the time previously set.

- After recording, normal playback will start from the next passage and will be recorded into the SD RAM automatically.
- During playback and recording, you can press **ALBUM** ▲/▼ to change the repeat times (1 time by default or 9 at most).
- During Follow and recording, you can press **PLAY/PAUSE** ▶|| to quit Follow and start the normal playback of the next passage.
- You can also press **LOOP** or **COMPARE** to quit the Follow mode and start Loop or Compare for the current passage.

A-B FOLLOW

Please refer to the **A-B** repeat operation procedure for the CD or Tape Loop mode.

LANGUAGE LEARNING

AUTO FOLLOW

- In the manual Follow mode, press **MODE** to switch to auto follow from manual follow.
→ **AUTO** flashes on the display.



- Notes :** - The set will quit the ongoing manual follow and start from the next passage to detect the interval between sentences during playback, so that one or several sentences will be repeated in the auto follow mode.
- During auto follow (during normal playback or follow), you can press **SEARCH** ⏪ or **SEARCH** ⏩ to change the number of sentence breaks (1 by default or 9 at most).
 - Press **ALBUM** ▲ / ▼ to change the repeat times.
 - During auto follow, you can press **PLAY/PAUSE** ▶|| to skip to the next passage to start the normal playback of the next passage and break sentences automatically.
 - You can press **LOOP** to repeat the contents of the current passage (at the times previously set).
 - Or press **FOLLOW** or **COMPARE** to repeat the contents of the current passage in the follow or compare mode, and activate auto follow or compare functions.
 - During normal playback in the auto follow mode, you can press **LOOP** or **COMPARE** to switch to the auto loop or auto compare mode.
 - In the Auto Follow mode, you cannot activate the A-B language learning function.

MANUAL COMPARE

- In the language learning mode, press **COMPARE** to enter the manual compare mode.
→ **COMPARE** appears on the display.
→ The set will play the recorded content for 1 time and then start recording.
→ Playback and recording can be repeated (for 1 time by default).
→ After 1 time of compare playback, the set will start normal playback automatically.

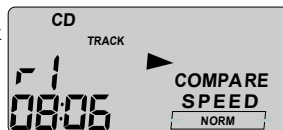

- Notes :** - The recording time equals the playback time.
- After recording, the original sound will be repeated once, followed by the recorded sound. The compare process (repeated playback + playback of original sound) will repeat at the times already set.
 - Once the normal playback is resumed, the next passage will start and will be recorded in the SD RAM synchronously.
 - During manual compare playback, recording, playback or repeated playback, you can press **ALBUM** ▲ / ▼ to change the repeat times (1 time by default and 9 times at most).
 - During manual compare playback, recording, playback or repeated playback, you can press **PLAY/PAUSE** ▶|| to exit the compare playback mode and play the next passage normally.
 - Or you can press **COMPARE** to repeat the compare playback for the ongoing passage (at the times already set).
 - You can press **LOOP** or **FOLLOW** to start the loop or follow for the current passage.

A-B COMPARE

Please refer to the **A-B** repeat operation procedure for the CD or Tape Loop mode.

AUTO COMPARE

- In the manual compare mode, press **MODE** to start Auto compare.
 - **AUTO** flashes on the display.
 - The set will quit the ongoing manual compare and start from the next passage to detect the interval between sentences during playback, so that one or several sentences will be repeated in the auto compare mode.
 - During auto compare (during normal playback or compare), you can press **SEARCH** ◀◀ or **SEARCH** ▶▶ to change the number of sentence breaks (1 by default or 9 at most).
 - Press **ALBUM** ▲ / ▼ to change the repeat times.
 - During auto compare, recording, repeated playback or recorded sound playback, you can press **PLAY/PAUSE** ▶|| to skip to the next passage to start the normal playback of the next passage and break sentences automatically.
 - You can press **COMPARE** to repeat the contents of the current passage (at the times already set).
 - Or press **LOOP** or **FOLLOW** to repeat the contents of the current passage in the loop or follow mode, and activate auto loop or compare functions.
 - During auto compare mode, you can press **LOOP** or **FOLLOW** to switch to the auto loop or auto follow mode.



CHANGING PLAYBACK SPEED

In any language learning mode, you can press **SPEED+/-** to change the playback speed. Five speeds are available: 0.5x, 0.75x, normal, 1.25x and 1.5x.

Note : - This feature is not available in the music playback mode.

CASSETTE RECORDER

CASSETTE PLAYBACK

1. Set the source selector to **TAPE/OFF**.
2. Press **STOP•OPEN** ■ ▲ to open the cassette holder.
3. Insert a recorded cassette.
4. Press **PLAY** ◀ and playback will start.
5. Adjust the sound using the **VOLUME** control.
6. For brief interruptions, press **PAUSE II**. Press **PAUSE II** again to resume playback.
7. By pressing ◀◀ or ▶▶, fast winding of the tape is possible in both directions.
8. To stop playback, press **STOP•OPEN** ■ ▲
→ The keys are automatically released at the end of the tape.
9. Set the source selector to **TAPE/OFF** position (with the cassette keys released) to switch off the set.

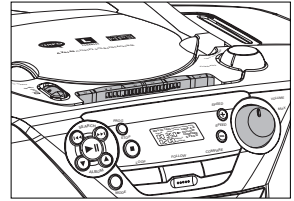

CASSETTE RECORDING

General information on cassette recording

- Recording is permissible insofar as copyright or other rights of third parties are not infringed.
- This deck is not suitable for recording on CHROME (IEC II) or METAL (IEC IV) type cassettes. For recording you should use NORMAL type cassettes (IEC I) on which the tabs have not been broken.
- Check and tighten slack tape before use with a pencil, to avoid jamming the deck mechanism.
- The recording level is set automatically. Altering the **VOLUME** control will not affect the recording in progress.

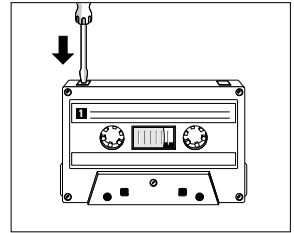

Note : No recording will take place during the first 7 seconds of the tape.

- To prevent accidental erasure of a recording, keep the cassette side to be safeguarded in front of you and break the left tab. Recording on this side is no longer possible.

RECORDING FROM THE RADIO

1. Set the source selector to **FM** or **MW**.
2. Tune to the desired radio station using the TUNING knob.
3. Press **STOP•OPEN** ■ ▲ to open the cassette holder.
4. Insert a blank tape.
5. Press **RECORD** ● to start recording.
6. For brief interruptions, press **PAUSE II**. To resume recording, press **PAUSE II** again.
7. To stop recording, press **STOP•OPEN** ■ ▲

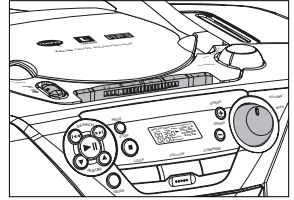

SYNCHRO START CD RECORDING

1. Set the source selector to **CD•MP3**.
2. Insert a CD and if desired, programme track numbers.
3. Press **STOP•OPEN** ■ ▲ to open the cassette holder.
4. Insert a blank cassette.
5. Press **RECORD** ● to start recording.
→ Playback starts automatically from the beginning of the programme. It is not necessary to start the CD player separately.
6. For brief interruptions, press **PAUSE II**. To resume recording, press **PAUSE II** again.
7. To stop recording, press **STOP•OPEN** ■ ▲

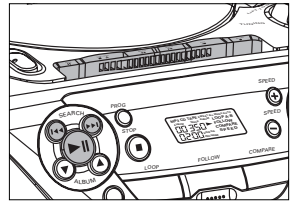

To select and record a particular passage within a track

1. Press and hold **SEARCH** ◀◀ or ▶▶ to select a passage.
2. Press **PLAY/PAUSE** ▶II.
→ Recording will start from this exact point when you press **RECORD** ● and **PLAY** ◀

INTERRUPT RECORDING SYNCHRONOUSLY

1. During recording from the CD/MP3 source, if playback is paused or stopped, tape recording will also be paused automatically.
2. When you press **PLAY/PAUSE** ▶II to resume playback, tape recording will also be resumed synchronously.

MAINTENANCE

PRECAUTIONS & GENERAL MAINTENANCE

- Place the set on a hard, flat surface so that the system does not tilt.
- Always shut the CD door to keep the CD compartment dust-free. To clean, dust the compartment with a soft dry cloth.
- The mechanical parts of the set contain self-lubricating bearings and must not be oiled or lubricated.
- To clean the set, use a soft, slightly dampened chamois leather. Do not use any cleaning agent containing alcohol, ammonia, benzene or abrasives as these may harm the housing.
- The ventilation should not be impeded by covering the ventilation openings with items, such as newspapers, table-cloths, curtains, etc.
- No naked flame sources, such as lighted candles, should be placed on the apparatus.
- No objects filled with liquids, such as vases, shall be placed on the apparatus.
- Apparatus shall not be exposed to dripping or splashing.

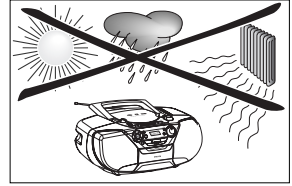

CD PLAYER AND CD HANDLING

- The lens of the CD player should *never be touched*.
- Sudden changes in the surrounding temperature can cause condensation to form and the lens of your CD player to cloud over. Playing a CD is then not possible. Do not attempt to clean the lens but leave the set in a warm environment until the moisture evaporates.
- Use only Digital Audio CDs.
- To take a CD out of its box, press the centre spindle while lifting the CD.

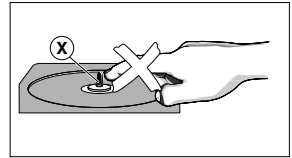

Always pick up the CD by the edge and replace the CD back in its box after use to avoid scratching and dust.

- To clean the CD, wipe in a straight line from the centre towards the edge using soft, lint-free cloth. Do not use cleaning agents as they may damage the disc.
- *Never write* on a CD or attach stickers to it.

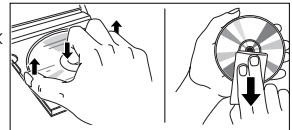

TAPE DECK MAINTENANCE

To ensure a good recording and playback of the tape, clean parts (A), (B) and (C) shown in the diagram, after about 50 hours of operation, or once a month. Use a cotton bud slightly moistened with alcohol or special head cleaning fluid to clean the deck.

- Open the cassette holder by pressing **STOP•OPEN** ■ ▲.
- Press **PLAY** ◀ and clean the rubber pressure rollers (C).
- Press **PAUSE** II and clean the magnetic head (A) and also the capstan (B).
- After cleaning, press **STOP•OPEN** ■ ▲.

You can also clean the magnetic head by playing a clearing cassette tape through once.

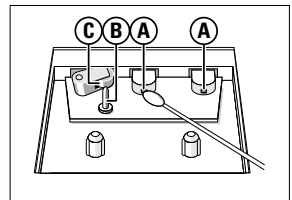

If a fault occurs, first check the points listed below before taking the set for repair. If you are unable to remedy a problem by following these hints, consult your dealer or service centre.

WARNING: *Do not open the set as there is a risk of electric shock. Under no circumstances should you try to repair the set yourself, as this will invalidate the guarantee.*

Problem	Solution
"NO DISC" is displayed	<ul style="list-style-type: none"> - Insert a disc and check if the disc is upside down. - Wait until the moisture condensation at the lens has cleared. - Replace or clean the disc, see "Maintenance" - Use a readable disc or an MP3-CD recorded in the correct format.
Radio reception is poor	<ul style="list-style-type: none"> - If the signal is too weak, adjust the antenna for better reception. - Increase the distance between the Receiver and your TV or VCR.
Recording or playback cannot be made	<ul style="list-style-type: none"> - Clean deck parts, see "Maintenance". - Use only NORMAL (IEC I) tape. - Apply a piece of adhesive tape over the missing tab space.
The system does not react when the buttons are pressed /The set does not work / No display on LCD. Sound cannot be heard or is of poor quality	<ul style="list-style-type: none"> - Slide the source selector to TAPE/OFF. Remove the AC power plug and reconnect it 30 seconds later and then switch on the system again. - Adjust the volume. - Make sure the MP3-CD was recorded within 32-320 kbps (128kbps preferably) with sampling frequencies at 8 - 48 kHz (44.1kHz preferably).
Loop, Follow or Compare is not available	<ul style="list-style-type: none"> - Check if the language learning mode is activated. Press and hold MODE until LANG ON appears on the display. Then the language learning is activated.
The set does not break sentences automatically	<ul style="list-style-type: none"> - The CD disc may be scraped. Please replace the disc with a new one. - If in the tape mode, the tape quality may be poor. Please use a good tape.
The playing speed cannot be changed	<ul style="list-style-type: none"> - The playing speed can be changed only in the language learning mode. - Please activate Loop, Follow or Compare function in the language learning mode first.